

product brochure 2023

Millpac, T/A Tag Plastic Extrusions Ltd, 21 Marsh Green Road, Marsh Barton, Exeter, EX2 8NY, England

t: + 44 (0) 1392 201225 e: sales@millpac.co.uk



1 - about us

2 – ribbed jar lids

3 – plain jar lids

4 – ribbed bottle caps

5 – plain bottle caps

6 – peg caps

7 – jars

8 – vials

9 – dispensing caps

10 – FEA push on caps

9 – miscellaneous

Millpac, T/A Tag Plastic Extrusions Ltd, 21 Marsh Green Road, Marsh Barton, Exeter, EX2 8NY, England

t: + 44 (0) 1392 201225 e: sales@millpac.co.uk

index



- injection moulding machines from 15 to 320T
 - over 30 years of plastic moulding experience
 - 50,000 sq ft manufacturing facility
- most thermoplastics processed – PP, PE, PC, HIPS, SAN, ABS, PET, Surlyn, Nylon & many recycled polymers
 - 2D & 3D Design Capabilities
 - ISO9001 accredited
 - automated assembly lines
 - onsite tool making facilities
 - flexible & rigid extrusion lines
- contact us for a professional & friendly service



Lined	
Description	Tool Ref
15mm R3 Hex Ribbed Cap	T069
15mm R3 Fine Ribbed Cap	T092
17mm R3 Fine Ribbed Cap	T088
18mm R3 Fine Ribbed Cap	T139/145
21mm R3 Fine Ribbed Cap	T096
22mm R3 Hex Ribbed Cap	T060
27mm R3 Fine Ribbed Cap	T056
28mm R3 Hex Ribbed Cap	T045
28mm R3 Ribbed Cap	T050
28mm R3 Ribbed Embossed Cap	T086
28mm R3 "Keep Upright" Cap	T082
28mm R3 Ribbed Embossed Cap	T108
38mm R3 Ribbed Cap	T098
38mm R3 Ribbed Twist Off Cap	T142
43mm R3 Ribbed Twist Off Cap	T120
45mm R3 Hex Ribbed Cap	T105
51mm R3 Fine Ribbed Cap	T054
58mm R3 Fine Ribbed Cap	T038
58mm Twist Off Cap	T119
82mm Ribbed Twist Off Cap	T122
89mm R3 Ribbed Cap	T021C
110mm R3 Ribbed Cap	T036/7

- from 15mm to 110mm
- lined or bore seal
- contact us with your requirements

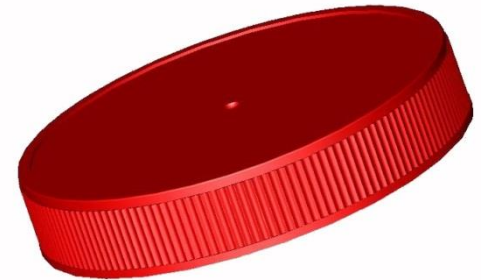

Bore Seal	
Description	Tool Ref
24mm R3 Bore Seal Cap	T106
24mm R3 Fine Ribbed Bore Seal Cap	T125
43mm R3 Ribbed Bore Seal Cap	T043
48mm R3 Ribbed Bore Seal Cap	T055
58mm R3 Ribbed Bore Seal Cap	T146
58mm R3 Ribbed Bore Seal Cap	T113
58mm R3 Ribbed Bore Seal Cap	T141
70mm Ribbed Bore Seal Cap	T118
58mm R3 Ribbed Bore Seal Cap	T124



Millpac, T/A Tag Plastic Extrusions Ltd, 21 Marsh Green Road, Marsh Barton, Exeter, EX2 8NY, England

t: + 44 (0) 1392 201225 e: sales@millpac.co.uk



plain jar lids

Description	Tool Ref
28mm R3 Plain Lid	T178
30mm Plain Lid	T066
30mm R3 Plain Radius Bore Seal Lid	T059
33mm Plain Bore Seal Lid	T044A
33mm Plain Lid	T051
38mm R3 Plain Lid	T132
38mm Plain Bore Seal Lid	T044B
40mm R3 Plain Lid	T177
43mm Plain Radius Lid	T093
48mm R3 Plain Lid	T136
53mm R3 Plain Lid	T041
58mm R3 Plain Radius Lid	T129
58mm R3 Thick Walled Plain Lid	T141
60mm R3 Plain Lid	T137
63mm R3 Plain Lid	T024
66mm R3 Plain Radius Lid	T052
70mm R3 Bore Seal Lid	T009
70mm R3 Plain Lid	T016/073
89mm R3 Plain Lid	T021A
100mm Plain Lid	T014

- from 30mm to 100mm
- lined or bore seal
- contact us with your requirements
- can easily be customised with debossed/embossed logos

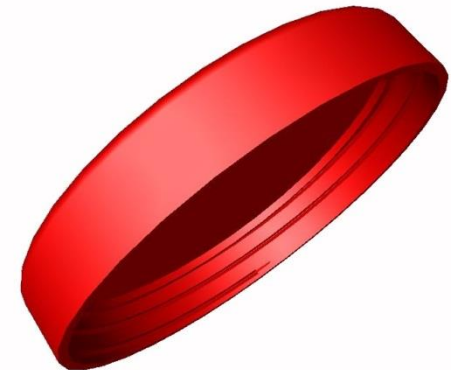
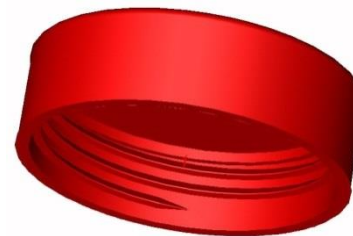
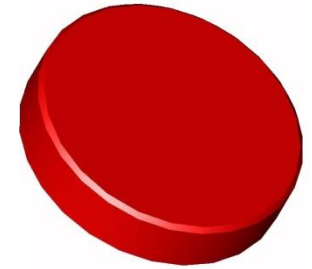

Millpac, T/A Tag Plastic Extrusions Ltd, 21 Marsh Green Road, Marsh Barton, Exeter, EX2 8NY, England

t: + 44 (0) 1392 201225 e: sales@millpac.co.uk



Description	Tool Ref
18mm R4 Semi Ribbed Cap	T047A
20mm R4 Fine Ribbed Bore Seal Cap	T076
20mm R4 Fine Ribbed Cap	T128
22mm R6 Fine Ribbed Cap	T064A
22mm Ribbed Bore Seal Cap	T025
24mm R4 Ribbed Cap	T068
24mm R4 Fine Ribbed Cap	T130
28mm R6 Ribbed Cap	T007
28mm Fine Ribbed Jigger Cap	T002
28mm R4 Hex Ribbed Embossed Cap	T049
28mm R4 Fine Ribbed Cap	T061
28mm Fine Ribbed Bore Seal Jigger Cap	T010
28mm R6 Ribbed Bore Seal Cap	T151
28mm R6 Ribbed Matt Cap	T138
31mm R6 Fine Ribbed Cap	T103A
31mm R6 Fine Ribbed bore Seal Cap	T103B
38mm R4 Cap	T114
38mm R4 Hex Ribbed Cap	T004
38mm Ribbed Cap	T008
38mm Tamper Evident Cap	T015
38mm R6 Hex Ribbed Cap	T144
40mm R4 Hex Ribbed Cap	T070
40mm Fine Ribbed Jigger Cap	T001

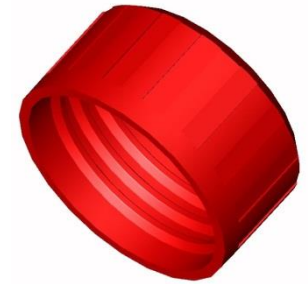
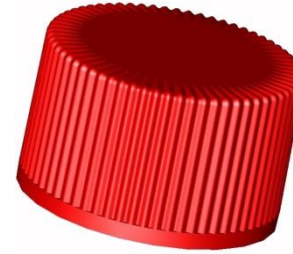

- from 10mm to 40mm
- lined or bore seal
- contact us with your requirements

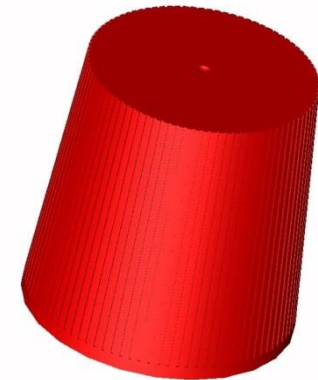
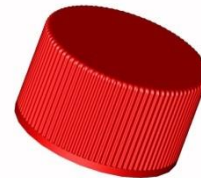

Millpac, T/A Tag Plastic Extrusions Ltd, 21 Marsh Green Road, Marsh Barton, Exeter, EX2 8NY, England

t: + 44 (0) 1392 201225 e: sales@millpac.co.uk



plain bottle caps

Description	Tool Ref
13mm Tall Radius Rollette Cap	T084
18mm R4 Plain Cap	T047B
18mm R4 Tall Radius Cap	T057
18mm R4 R/T Matt Cap	T140
20mm R4 Plain Cap	T128A
20mm R4 Tall Radius Cap	T062
22mm R4 Tall Radius Cap	T112A
22mm R4 Reverse Taper Cap	T152
22mm R6 Plain Cap	T064B
22mm R6 Tall Radius Cap	T112B
24mm R4 Plain Cap	T130A
24mm R4 Tall Radius Cap	T034A
24mm 410 Smooth Sided Cap	T134B
24mm R6 Tall Radius Cap	T034B
28mm R6 Tall Radius Cap	T032
28mm Plain Bore Seal Double Wall Cap	T110
31mm Double Wall Cap	T102
70mm Spice Overcap	T035/080
Wet Wipes Cap	T200

- from 13mm to 80mm
- lined with a choice of liners
- contact us with your requirements

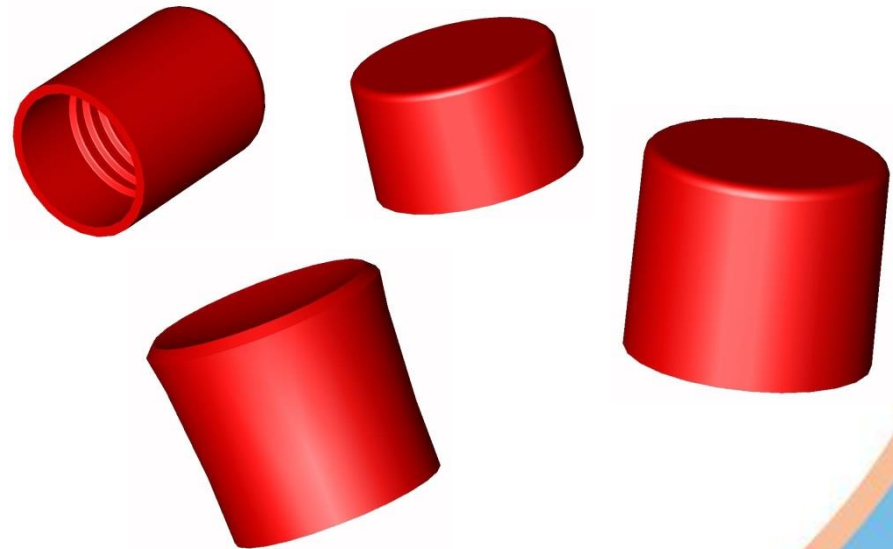

Millpac, T/A Tag Plastic Extrusions Ltd, 21 Marsh Green Road, Marsh Barton, Exeter, EX2 8NY, England

t: + 44 (0) 1392 201225 e: sales@millpac.co.uk



Description	Tool Ref
18mm R4 Ribbed Peg Cap	T039
18mm R4 Semi Ribbed Peg Cap	T067
20mm R3 Hex Ribbed Peg Cap	T040
22mm R3 Hex Ribbed Peg Cap	T060A
24mm R3 Hex Ribbed Peg Cap	T042
24mm R4 Hex Ribbed Peg Cap	T134
24mm Hex Sprinkler Cap	T065
28mm Hex Ribbed Peg Cap	T045B

- from 18mm to 24mm
- polycone, spatula or sprinkler fitments supplied
 - contact us with your requirements

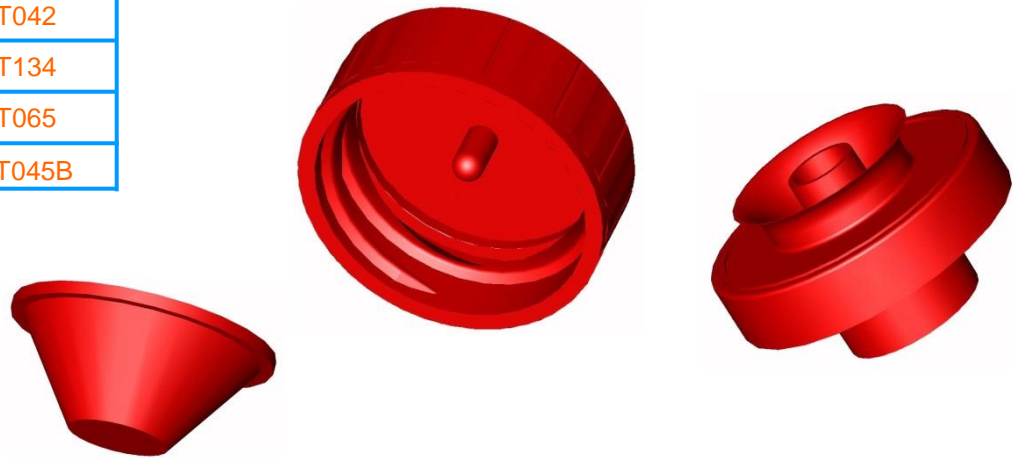

Millpac, T/A Tag Plastic Extrusions Ltd, 21 Marsh Green Road, Marsh Barton, Exeter, EX2 8NY, England

t: + 44 (0) 1392 201225 e: sales@millpac.co.uk

Description	Tool Ref
5ml Jar	T161
10ml Jar	T160
15ml Thick Walled Jar	T159

- range constantly increasing – available in SAN or PET
- contact us with your requirements
- supplied with or without lids



jars

Millpac, T/A Tag Plastic Extrusions Ltd, 21 Marsh Green Road, Marsh Barton, Exeter, EX2 8NY, England

t: + 44 (0) 1392 201225 e: sales@millpac.co.uk

Description	Tool Ref
5ml Vial	T109
5ml Vial	T131
10ml Vial	T150
15ml Vial	T090
28ml Vial	T018
30ml Vial	T117
45ml Vial	T127
60ml Short Vial	T087
60ml Tall Vial	T089
80ml Vial	T031
90ml Vial	T148
120ml Vial	T123
Universal Vial	T104
Universal Vial	T107

- from 5ml to 120ml – available in GPPS or PP
- supplied with or without caps
- contact us with your requirements



Dispensing caps

Description	Tool Ref
20/410 Disc Top Cap	C3368
24/410 Disc Top Cap	C3369
28/410 Flip Top Cap	C3397

- Available in a range of standard or bespoke colours
 - Flip top Cap Available – 3 Orifice Sizes 5mm, 3mm & 1.5mm
 - contact us with your requirements



Millpac, T/A Tag Plastic Extrusions Ltd, 21 Marsh Green Road, Marsh Barton, Exeter, EX2 8NY, England

t: + 44 (0) 1392 201225 e: sales@millpac.co.uk

Description	Tool Ref
15mm FEA Crimp Push On Cap	C3274
15mm FEA Collar Push On Cap	C3297

- Available in a range of standard or bespoke colours
 - contact us with your requirements



Millpac, T/A Tag Plastic Extrusions Ltd, 21 Marsh Green Road, Marsh Barton, Exeter, EX2 8NY, England

t: + 44 (0) 1392 201225 e: sales@millpac.co.uk



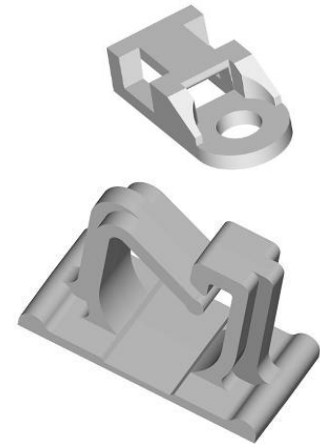
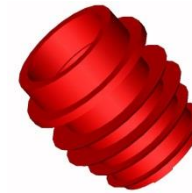
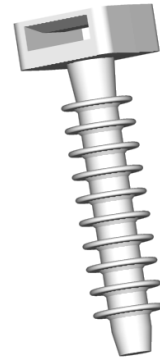
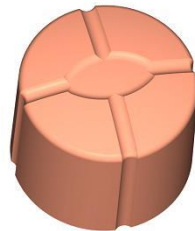
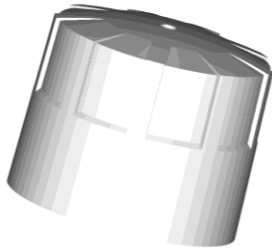
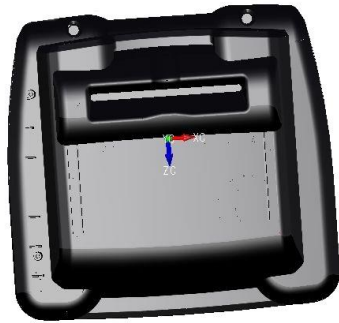

- many types of plastic mouldings produced in most thermoplastic materials
- full design capabilities
- contact us with your custom design requirements

miscellaneous

Millpac, T/A Tag Plastic Extrusions Ltd, 21 Marsh Green Road, Marsh Barton, Exeter, EX2 8NY, England

t: + 44 (0) 1392 201225 e: sales@millpac.co.uk